

TURO™ 7236 LH

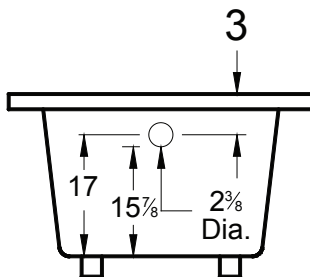
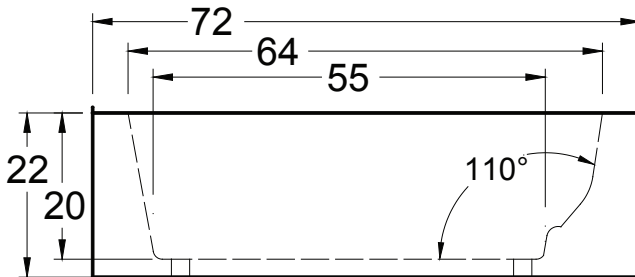
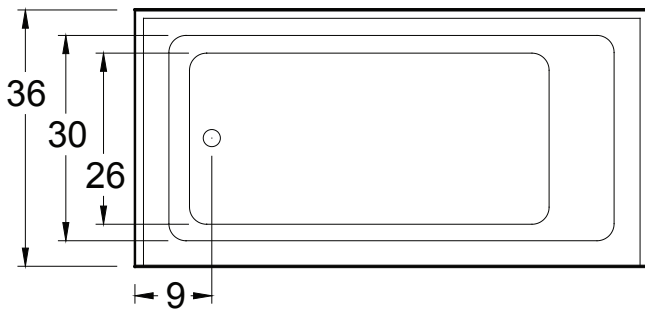

DIMENSIONS

72" x 36" x 22" (1829 x 914 x 559 mm)

Whirlpool Operating Gallons = 72 (Liters = 273)

Gallon to Overflow = 95 (Liters = 360)

MATERIAL

Acrylic

TUB FLOOR

Non - Textured

UNDERMOUNT:

This tub is not designed for undermount installation

APPROVALS & COMPLIANCE



Americh products meet or exceed the following standards:

- Underwriters Laboratories (UL)
- Underwriters Laboratories - Canada (cUL)
- ANSI Z124.1 • ANSI A112-19.7
- ANSI A112.19.8

Contact Americh for additional approvals.

STANDARD EQUIPMENT

- Apron
- Molded Tile Flange
- Adjustable feet

LEGEND



Pump



Blower



Jet



Rotary Jet



Suction



Light



ON/OFF Control



Grab Bar



Access Panel
(See Installation Tips)



Mfg ID Label

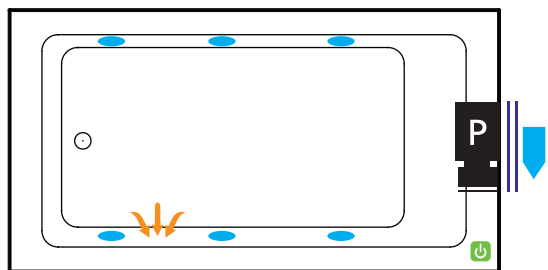

Builder Series

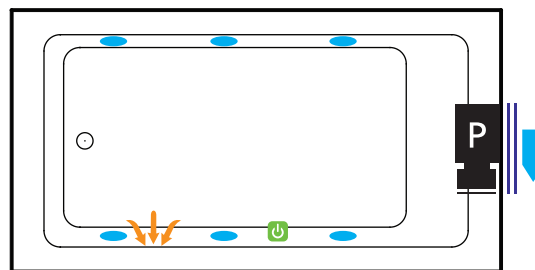

Luxury Series

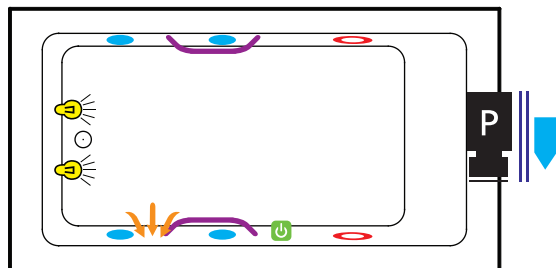

Platinum Series

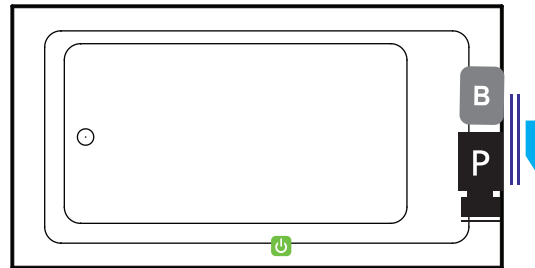

Combination
(pump and blower location only)

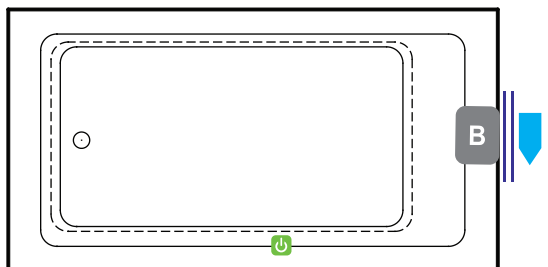

Airbath System II

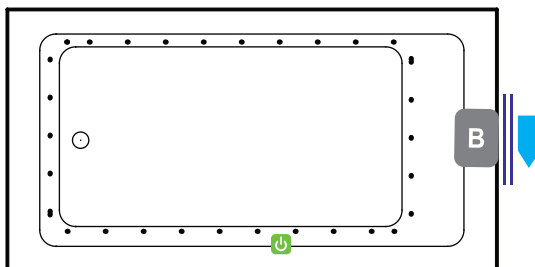

Airbath System V

OPTIONAL ACCESSORIES

- ANEX (Americh Nanobubble Experience)
- Chromatherapy★
- Grab Bars: 9"★ - 14" - 16"
- High Density Insulation★
- iBath Sound System
- Inline Heater (whirlpool only)
- Jets: Additional or Rotary★
- Ozone System (whirlpool and/or Airbath only)
- Pillows: 12" - Angle★
- Remote Control Upgrade (select series only)
- Serenity Soak (tub only)
- Syllent Pump with Heated Air★
- TCS - Thermal Comfort System
- Trim Kit Upgrade★
- Waste & Overflow Upgrades
 - Cable Drive Waste & Overflow★
 - PVC Waste & Overflow
 - Linear Waste & Overflow

(★) Standard on Platinum Series

INSTALLATION TIPS

1. Install according to Owner's Manual and local codes.
2. Always consult your local plumber for recommendations as installations will vary.
3. Any tub with a single system requires an access panel with minimum dimensions of 16" high x 20" wide.
4. Bathtubs with a combination of systems will require an access panel with minimum dimensions of 16" high by 28" wide. Tubs with multiple systems may require two separate access panels depending on the tub configuration and equipment.
5. The combination of multiple systems and options may require components to stick out and/or be remotely installed in the field. Check with factory before ordering.
6. Hot water supply should be 65%-75% of tub capacity or greater.

ELECTRICAL REQUIREMENTS

Americh recommends one 20 amp ground fault circuit interrupter (GFCI) for each power supply provided with the bathtub.