

## BOW® 6632 LH



### DIMENSIONS

66" x 32" x 21" (1676 x 813 x 533 mm)  
Whirlpool Operating Gallons = 36 (Liters = 136)  
Gallon to Overflow = 62 (Liters = 235)

### MATERIAL

Acrylic (All Americh Standard Colors)

### TUB FLOOR

Non - Textured

### UNDERMOUNT: No

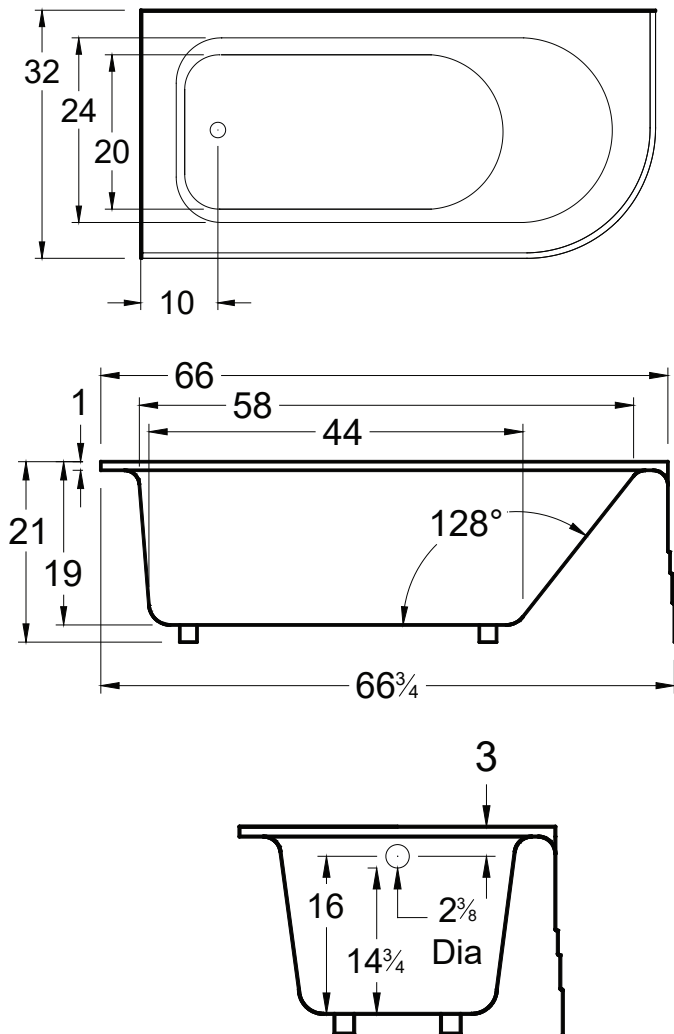

### CODES & COMPLIANCE

Americh products meet or exceed the following standards:

- Underwriters Laboratories (UL)
- Underwriters Laboratories - Canada (cUL)
- Canadian Standards Association - (CSA)
- ANSI Z124.1 • ANSI A112-19.7
- ANSI A112.19.8

Contact Americh for additional approvals.

### STANDARD EQUIPMENT

- Apron
- Tile Flange
- Adjustable Feet

## BATHING SYSTEMS

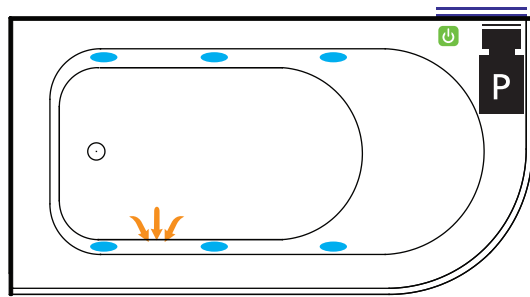

Builder Series

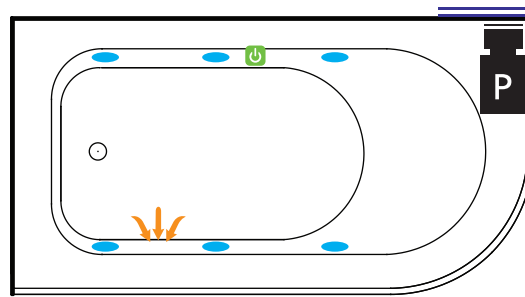

Luxury Series

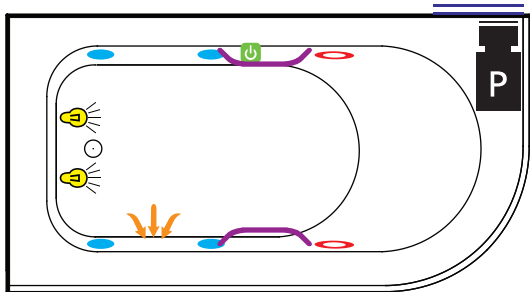

Platinum Series

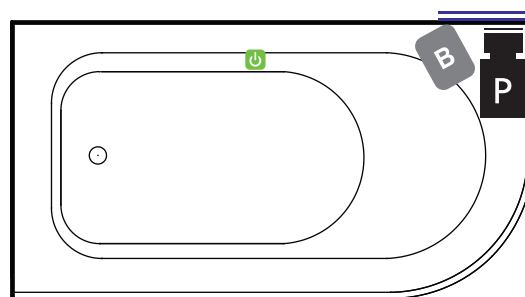

Combination  
(pump and blower location only)

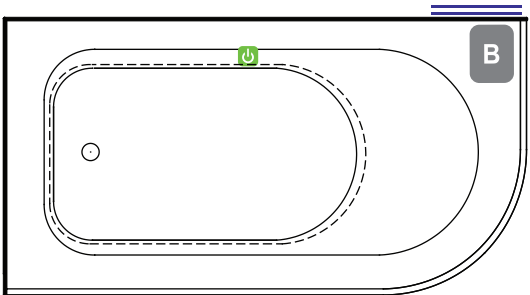

Airbath System II

**N/A**

Airbath System III

## LEGEND



Pump



Blower



Jet



Rotary Jet



Suction



Light



ON/OFF Control



Grab Bar

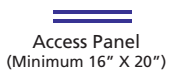

Access Panel  
(Minimum 16" X 20")

## OPTIONAL ACCESSORIES

- Chromatherapy\*
- Grab Bars: 9" \*- 14" - 16"
- High Density Insulation\*
- iBath Sound System
- Inline Heater (whirlpool only)
- Jets: Additional or Rotary\*
- Ozone System (whirlpool and/or Airbath only)
- Pillows: 12" \*
- Remote Control Upgrade (select series only)
- Serenity Soak (tub only)
- Syllent Pump with Heated Air\*
- Thermal Comfort System
- Trim Kit Upgrade\*
- Waste & Overflows Upgrades
  - Cable Drive Waste & Overflow\*
  - PVC Waste & Overflow+
  - Linear Waste & Overflow

## INSTALLATION TIPS

- Install according to Owner's Manual and local codes.
- Any whirlpool or Airbath® unit requires an access panel.
- Hot water supply should be 65-75% of tub capacity or greater.
- Always consult your local plumber for recommendations as installations will vary.
- This unit accommodates corner installations only.
- The combination of multiple systems and options may require components to stick out and/or be remotely installed in the field.

## ELECTRICAL REQUIREMENTS

Americh recommends one 20 amp ground fault circuit interrupter (GFCI) for each power supply provided with the bathtub.

(\* Standard on Platinum Series (+) Standard on Luxury Series

Some functioning Optional Accessories may not be compatible when combining components, please contact Americh to confirm compatibility

Last Update 04/1/19

Always check the website for the most updated specifications: [Americh.com](http://Americh.com)